

**BA505C**  
**2-wire 4/20mA**  
**manual setpoint**  
**station**  
Issue 6



## CONTENTS

- 1. Description**
- 2. Operation**
- 3. Electrical Systems Design**
  - 3.1 4/20mA loop
  - 3.2 Optional Backlights
    - 3.2.1 Separately powered
    - 3.2.2 Loop powered
- 4. Installation**
  - 4.1 Location
  - 4.2 Installation procedure
  - 4.3 EMC
- 5. Calibration**
  - 5.1 Internal display
  - 5.2 Zero adjustment
  - 5.3 Span adjustment
  - 5.4 Decimal point
  - 5.5 Reverse action
  - 5.6 Calibration example
  - 5.7 Over and under-range
- 6. Maintenance**
  - 6.1 Fault finding during commissioning
  - 6.2 Fault finding after commissioning
  - 6.3 Servicing
  - 6.4 Guarantee
  - 6.5 Customer comments
- 7. Accessories**
  - 7.1 Scale card.
  - 7.2 Tag strip

## 1. Description

The BA505C is a loop powered set point station which enables the current flowing in a 4/20mA loop to be manually adjusted from within a process area.

The main application of the BA505C is the adjustment of plant parameters. Controller set points, actuator positions or any parameter controlled by a 4/20mA signal may be manually adjusted by a BA505C.

The BA505C incorporates a high resolution ten turn potentiometer to provide accurate adjustment and is fitted with a friction damper to minimise the possibility of accidental adjustment. The instrument incorporates a 3½ digit indicator which may be calibrated to display the 4/20mA loop current in engineering units. Optional display backlighting is available for installations in poorly illuminated areas.

The BA505C is a second generation instrument offering improved performance and an IP65 sealed front panel. For hazardous area applications the complementary BA405C has been certified intrinsically safe by Baseefa and FM.

## 2. Operation

Fig 1 shows a simplified block diagram of the manual set point station. The ten turn control knob enables the current flowing in the loop to be manually set at any value between approximately 3.5 and 21mA. The output resistance of the BA505C is very high so the loop current will be unaffected by changes in supply voltage.

The 3½ digit integral indicator is powered by the 4/20mA loop current and can easily be calibrated on-site. For example, in an application where the BA505C is being used to adjust the set point of a speed controller, the internal indicator could be calibrated to display the required speed in RPM. Optional display backlighting is powered from a separate supply.

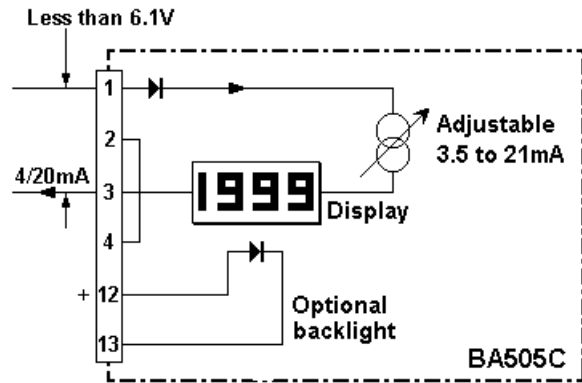

Fig 1 Simplified block diagram of BA505C

## 3. Electrical System Design

### 3.1 4/20mA loop

The BA505C requires an operating voltage between 6.1 and 30V. Design of the loop is similar to that for a 2-wire temperature or pressure transmitter.

Fig 2 illustrates a typical application in which a BA505C is powered from a common supply. When designing the loop it is only necessary to establish that the maximum voltage drop caused by the manual set point station, the load and cable resistance is always less than the minimum supply voltage.

For example:

Minimum operating voltage of BA505C	6.1V
Maximum voltage drop caused by speed controller which is a 250ohm load (250ohms x 20mA)	5.0V
Maximum voltage drop caused by cable resistance (10ohms x 20mA)	0.2V
	-----
Total maximum voltage drop	11.3V

The power supply voltage must therefore be greater than 11.3V, but less than 30V which is the maximum operating voltage of the BA505C.

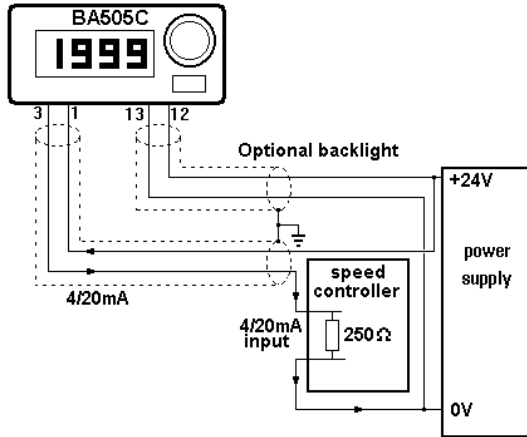

Fig 2 Application with separately powered backlight.

**3.2 Optional Backlights**

The BA505C can be supplied with a separately powered or a loop powered backlight. The separately powered backlight provides bright amber illumination but requires additional field wiring. The loop powered backlight provides green background illumination enabling the display to be read at night or in poorly illuminated areas, but increases the BA505C minimum operating voltage to 10V.

**3.2.1 Separately powered backlight**

The backlight is electrically isolated from the measuring circuit and may be powered from any 14 to 30V dc supply as shown in Fig 2. The backlight brilliance may be reduced by reducing the supply voltage below 14V, or by fitting a current limiting resistor in series with the supply.

**3.2.2 Loop powered backlight**

The loop powered backlight is connected in series with, and powered by, the 4/20mA current from the set point station as shown in Fig 2A. This eliminates the need for additional field wiring, but the minimum operating voltage of the set point station is increased from 6.1 to 10.0V.

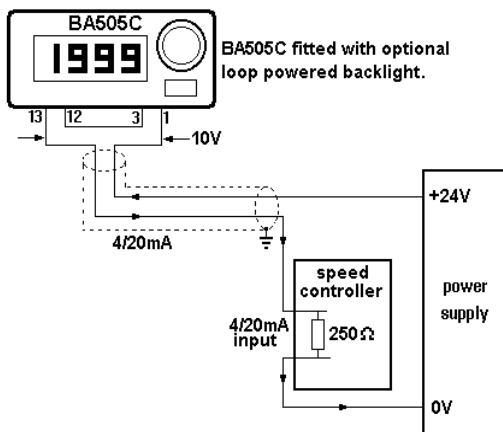

Fig 2A Application with loop powered backlight

**4. Installation**

**4.1 Location**

The BA505C is housed in a robust aluminium enclosure with a polyester front panel and a Noryl bezel. The front panel provides IP65 protection and a gasket seals the joint between the instrument and the front panel. The BA505C may be installed in any panel providing the environmental limits shown in the specification are not exceeded.

Fig 3 shows the enclosure dimensions and the recommended panel cut-out dimensions.

**Cut-out Dimensions**

DIN 43 700

92.0 +0.8/-0.0 x 45.0 \_0.6/-0.0

To achieve an IP65 seal between

BA505C and instrument panel

90.0 +0.5/-0.0 x 43.3 +0.5/0.0

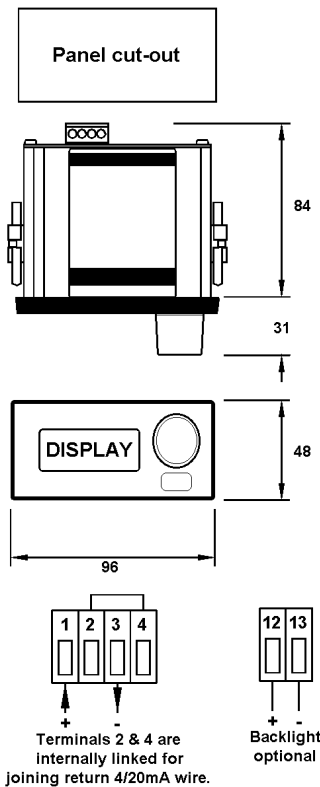

Fig 3 BA505C dimensions

**4.2 Installation Procedure**

- a. Insert the BA505C set point station into the panel aperture from the front. Ensure that the gasket is correctly positioned behind the bezel.

- b. Fix two panel mounting clips to opposite sides of the instrument and tighten until the indicator is secured as shown in Fig 4.
- c. Connect the panel wiring to the rear terminal block(s) as shown in Fig 3. To simplify installation, the terminals are removable so that the panel wiring can be completed before the instrument is installed.

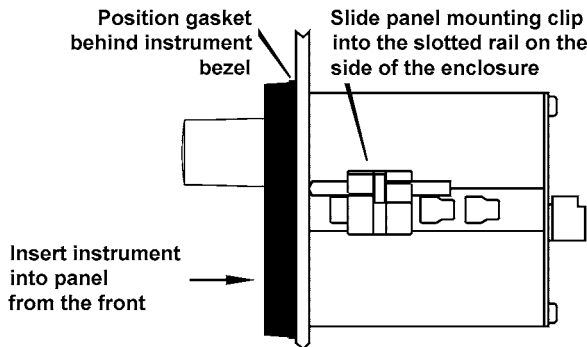

Fig 4 Fitting panel mounting clips

For maximum accuracy the display should be calibrated using a traceable current measuring device with an accuracy greater than  $4\mu\text{A}$ .

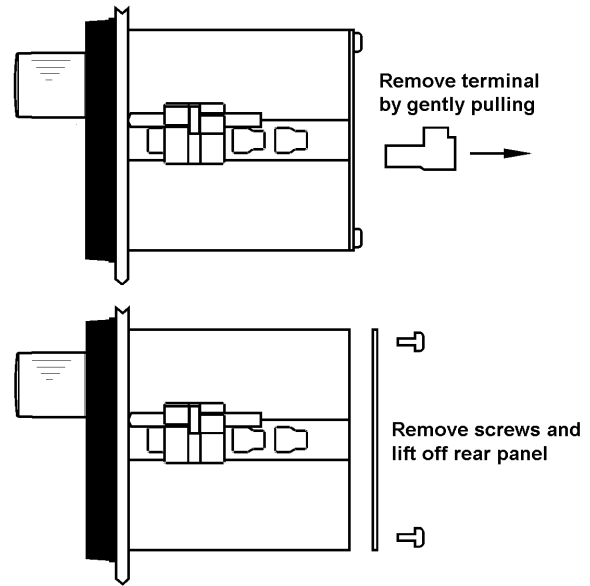

Fig 5 Removal of rear panel

### 4.3 EMC

The BA505C complies with the requirements of the European EMC Directive. For specified immunity all wiring should be in screened twisted pairs. The indicator enclosure may be earthed locally by securing a tag under one of the rear panel corner fixing screws.

## 5. Calibration

The front panel multi-turn control adjusts the set point station's output current between approximately 3.5 and 21mA, no calibration is required.

### 5.1 Internal display

The BA505C internal display may be calibrated so that the 4/20mA loop current is shown in the required engineering units.

The BA505C display will be supplied calibrated as requested at time of ordering. If calibration is not requested, the display will be set to show 00.0 with 4.000mA loop current, and 100.0 with 20.000mA loop current, but may easily be recalibrated on-site.

The display is calibrated by plug-in links and two multi-turn potentiometers that are accessible through holes in the rear panel. To gain access to the links the rear panel must be removed as shown in Fig 5.

### 5.2 Zero adjustment

Zero is defined as the number displayed with a 4.000mA loop current, and may be adjusted between -1000 and 1000. The zero potentiometer has two ranges, 0 to 500 and 500 to 1000; the polarity of the zero is defined by the position of the suppression / elevation links. Fig 6 shows the position of the links and zero potentiometer.

#### Suppression / elevation links

Elevation	Positive zero	0 to 1000
or Suppression	Negative zero	0 to -1000

#### Zero link

0 to 500  
or 500 to 1000

### 5.3 Span adjustment

Span is defined as the difference between the number displayed at 4.000mA and the number displayed at 20.000mA loop current. The span potentiometer has four ranges defined by the span links, and may be adjusted to any number between 0 and 1999.

Fig 6 shows the position of the links and span potentiometer.

#### Span links

000 to 500  
or 500 to 1000  
or 1000 to 1500  
or 1500 to 1999

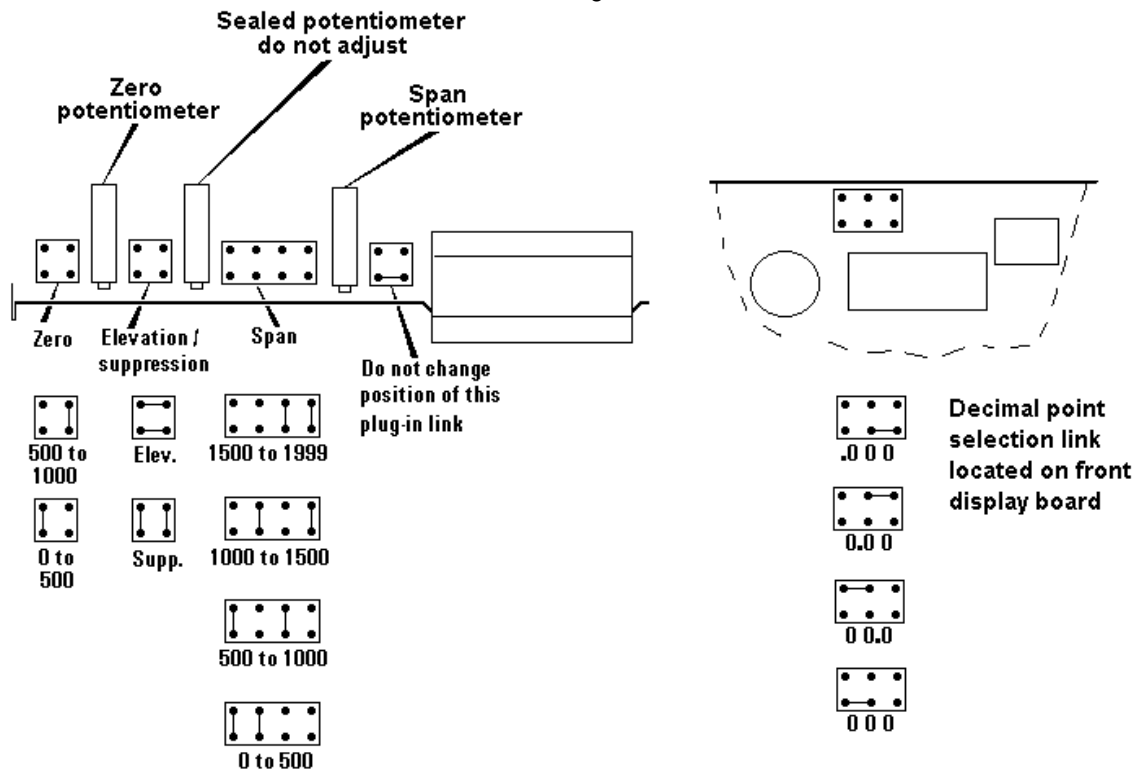

Fig 6 Position of calibration plug-in links and potentiometers

#### 5.4 Decimal point

A dummy decimal point may be displayed between any of the four digits. The position or absence of this decimal point is determined by the position of the decimal point link shown in Fig 6. When calculating the required span and zero settings the decimal point should be ignored.

#### 5.5 Reverse action

Normally the BA505C display increases as the loop current increases, but this can be reversed. Please contact BEKA associates for details.

#### 5.6 Calibration example

A BA505C is required to display:

25.0 with at 4.000mA loop current  
115.0 with at 20.000mA loop current

i.e. A zero of positive 250 } Ignoring decimal  
A span of 900 } point  
A decimal point in position 00.0

The following adjustments are required:

- Step 1 The BA505C is required to display a positive zero therefore the suppression / elevation links should be put in the elevation position.
- Step 2 The required zero is 250, therefore the zero link should be put in the 0 to 500 position.

- Step 3 The required span is 900, therefore the span links should be placed in the 500 to 1000 position.
- Step 4 The decimal point is required between the least two significant digits, therefore the decimal point link should be placed in the 00.0 position.
- Step 5 Adjust the BA505C front panel control until the external current measuring device indicates that the loop current is 4.000mA. Adjust the zero potentiometer at the rear of the BA505C until the BA505C displays 25.0
- Step 6 Adjust the BA505C front panel control until the external current measuring device indicates that the loop current is 20.000mA. Adjust the span potentiometer at the rear of the BA505C until the BA505C displays 115.0
- Step 7 Repeat steps 5 and 6 until both calibration points are correct. The span and zero controls are almost independent so it should only be necessary to repeat each adjustment twice.

### 5.7 Over and under-range

The BA505C can be calibrated to display numbers between -1999 and 1999. If this range is exceeded the three least significant digits will be blanked. Under-range is indicated by -1 and over-range by 1.

## 6. Maintenance

### 6.1 Fault finding during commissioning

If the BA505C set point station fails to function during commissioning the following procedure should be followed:

Symptom	Cause	Solution
No loop current	Incorrect wiring or no power supply	Check wiring and power supply polarity
Unstable loop current	Insufficient supply voltage	Check that voltage between terminals 1 & 3 is between 6.1 and 30V
BA505C displays 1	Positive over-range	The display has been incorrectly calibrated & is trying to show a number greater than 1999.
BA505C displays -1	Negative over-range	The display has been incorrectly calibrated & is trying to show a number less than -1999.
Unstable display	Power supply has voltage ripple	Reduce ripple

### 6.2 Fault finding after commissioning

#### ENSURE PLANT SAFETY BEFORE STARTING MAINTENANCE

If a BA505C fails after it has been functioning correctly, the following procedure should be followed:

Symptom	Cause	Solution
No loop current	Wiring or power supply fault	Check wiring and power supply
Unstable loop current	Insufficient supply voltage	Check that voltage between terminals 1 & 3 is between and 6.1 & 30V
Unstable display	Power supply has developed voltage ripple	Reduce ripple

If this procedure does not reveal the cause of the fault, it is recommended that the BA505C manual set point station is replaced with a spare instrument.

### 6.3 Servicing

The BA505C is difficult to service to component level on-site. All BA505C set point stations are interchangeable, and a single spare assembly can be used to replace any instrument which fails.

We recommend that, except under exceptional circumstances, suspect instruments are returned to BEKA associates or our local agent for repair.

### 6.4 Guarantee

Set point stations which fail within the guarantee period should be returned to BEKA associates or our local agent. It is helpful if a brief description of the fault symptoms is provided.

### 6.5. Customer comments

BEKA associates is always pleased to receive comments from customers about our products and services. All communications are acknowledged and whenever possible, suggestions are implemented.

## 7. Accessories

### 7.1 Scale card

The BA505C has a window below the multi-turn control knob to accommodate a scale card. The instrument can be supplied with a printed scale card showing any units specified at the time of ordering e.g. °C, mBar, RPM. If a printed scale card is not requested, a blank card will be supplied.

Scale cards can easily be marked on site as follows:

- a. Remove the rear terminal block(s) and the rear panel as shown in Fig 5.
- b. Remove the end cap of the front panel control knob that will reveal a screw head. Loosen this screw and carefully pull the control knob from the shaft.
- c. Pull the electronic assembly from the rear of the enclosure.
- d. Remove the blank scale card and mark with the required legend. Replace scale card taking care to align it within the front panel window.
- e. Slide the electronic assembly into the rear of the enclosure and guide the control shaft carefully through the front panel seal. Replace the rear panel and terminals.
- f. Replace the control knob, tighten the retaining screw and replace the control knob end cap.

### 7.2 Tag strip

The BA505C can be supplied with a thermally printed tag strip secured by rivets to the rear panel. This tag strip is not visible from the front of the instrument after installation.